

# **YANGOR**

## **User Manual**

### ***Model: Y20 Pro Max***

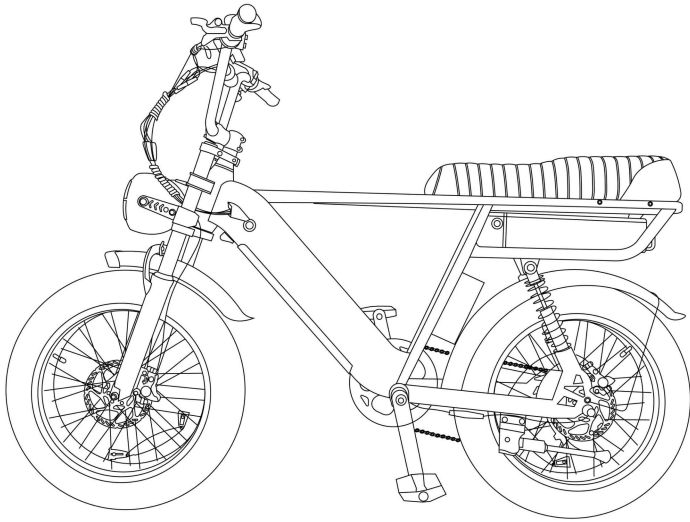

Please keep the instruction manual properly!

To ensure your safety, please read the instruction manual carefully before using the electric bicycle to better understand the performance of the electric bicycle.

# Content

<b>User Manual .....</b>	<b>1</b>
<b>Content .....</b>	<b>2</b>
<b>SAFETY INSTRUCTION .....</b>	<b>3</b>
<b>PRODUCT SPECIFICATION .....</b>	<b>5</b>
<b>PRODUCT DIAGRAM .....</b>	<b>6</b>
<b>DISPALY PANEL INSTRUCTION .....</b>	<b>7</b>
<b>INSTALLATION INSTRUCTIONS .....</b>	<b>10</b>
<b>PRECAUTIONS BEFORE RIDING.....</b>	<b>15</b>
<b>RECOMMENDATIONS FOR USAGE.....</b>	<b>17</b>
<b>MAINTENANCE AND REPAIR.....</b>	<b>22</b>
<b>WARRANTY CARD.....</b>	<b>25</b>
<b>DECLARATON OF CONFORMITY.....</b>	<b>26</b>

# SAFETY INSTRUCTION

**Dear users, thank you for choosing and purchasing our product. An EPAC is a motorized bicycle equipped with pedals and an auxiliary electric motor, which provide assistance up to a maximum speed of 25km/h when pedaling.**

**Before your first ride: please read the entire instruction carefully!**

- Strictly abide by local laws and regulations and traffic laws. The company is not responsible for any consequences caused by violation of the above laws and regulations.
- Strictly follow the instructions in the manual for corresponding operations. The company is not responsible for any consequences caused by improper use, speeding, overloading etc...
- This product is suitable for daily short-distance commuting. Please do not use it for dangerous performances such as competitions and stunts. Otherwise, it may cause damage to the bicycle or cause injury to the rider.
- It is recommended to wear a helmet when riding.
- Please regularly check whether the brake performance is good.
- Please always make sure the bike is in a good condition when riding.
- Please do not modify, repair or disassemble the product on your own.
- This vehicle can only ride alone, and do not carry people.
- Before turning on your E-bike, sit on it like a standard bicycle to get comfortable with the device before using it with the motor.
- It is forbidden for people under 16 years old to drive e-bike on the road.
- It is not allowed to use a trailer or kids trailer with this e-bike.

- People who should not ride the product include:
  - i. Anyone under the influence of alcohol or drugs.
  - ii. Anyone who suffers from disease that puts them at risk if they engage in strenuous physical activity.
  - iii. Anyone who has problems with balance or with motor skills that would interfere with their ability to maintain balance.
  - iv. Anyone whose weight is outside the stated limits (see Specifications)
- Never ride your e-bike with the kickstand down.
- Make sure the battery pack is fully charged before the first Initial use.
- Avoid using used, defective and/or non-original batteries.
- Do not leave the battery near fire or heat sources.
- Pay attention to waterproof to prevent battery pack from being exposed to water shower and immersion;
- If the battery pack didn't in use for a long time, be sure to remove it from the whole vehicle for storage;
- The battery pack should be stored in a clean, dry and ventilated place, and should avoid contact with corrosive substances, away from fire sources and heat sources;
- Storage temperature of battery pack: ≤1 month : -20~45°C, ≤3 months: -10~35°C, ≤12 months: -0~25°C,; Storage humidity ≤60%RH. The temperature of battery operation: -10~45°C . Battery charging temperature: 0~35°C;
- This bike comes with a non-zero start mode. When starting your riding, slide your foot forward a bit for assistance, then turn the throttle.
- The A-weighted emission sound pressure level at the driver's ears is less than 70 dB(A).

# PRODUCT SPECIFICATION

<b>Model No.</b>	Y20 Pro Max
<b>Frame Material</b>	Steel
<b>Suitable Height</b>	175-185cm
<b>Front Fork</b>	Suspension Fork
<b>Real Suspension</b>	Real Suspension
<b>Tire</b>	20*4.0
<b>Rear derailleur</b>	Shimano 7s RD-TY21-B-SS
<b>Brake</b>	hydraulic brake
<b>Chain</b>	KMC HV500
<b>Chain-wheel</b>	52T,aluminium
<b>Disc Diameter</b>	Rear: 160mm Front: 160mm
<b>Shifter</b>	SL-TX50-7R
<b>Pedal</b>	aluminum
<b>Fender</b>	Front & Rear
<b>Motor</b>	48V 250W
<b>Controller</b>	20A
<b>Sensor</b>	Speed sensor
<b>Charger</b>	54.6V 2A
<b>Charge time</b>	6-7 hours
<b>Display</b>	LCD
<b>Battery</b>	Battery 1: 48V 15Ah Battery 2: 48V 20Ah
<b>Support Gears</b>	Gear 1: 15km/h; Gear 2: 20km/h; Gear 3: 25km/h
<b>Max Speed</b>	25km/h
<b>Milage</b>	120km
<b>Product N.W / G.W</b>	45kg/53kg
<b>Product size</b>	1660*670*1150mm
<b>Carton Size</b>	1420*310*840mm

# PRODUCT DIAGRAM

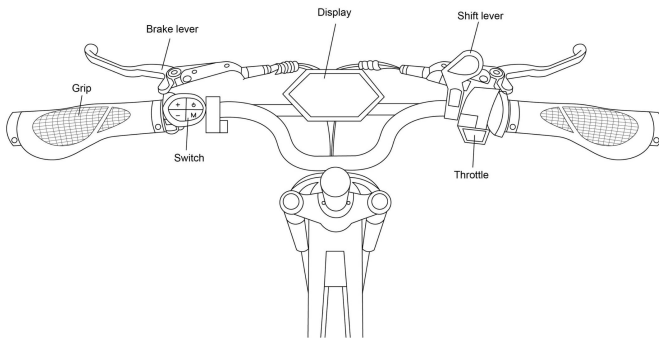
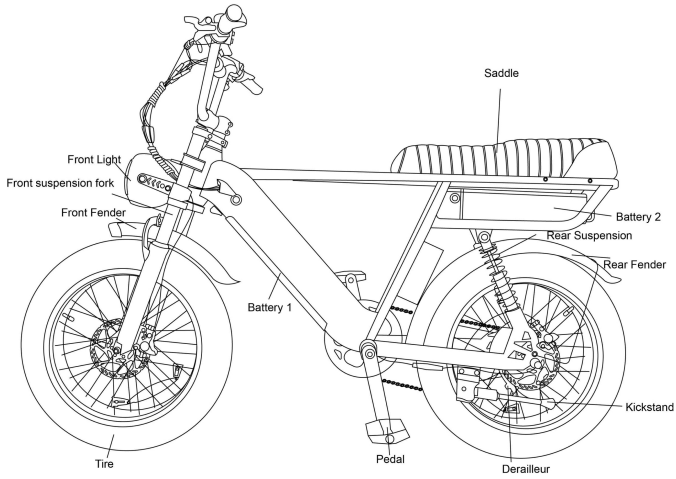

# DISPALY PANEL INSTRUCTION

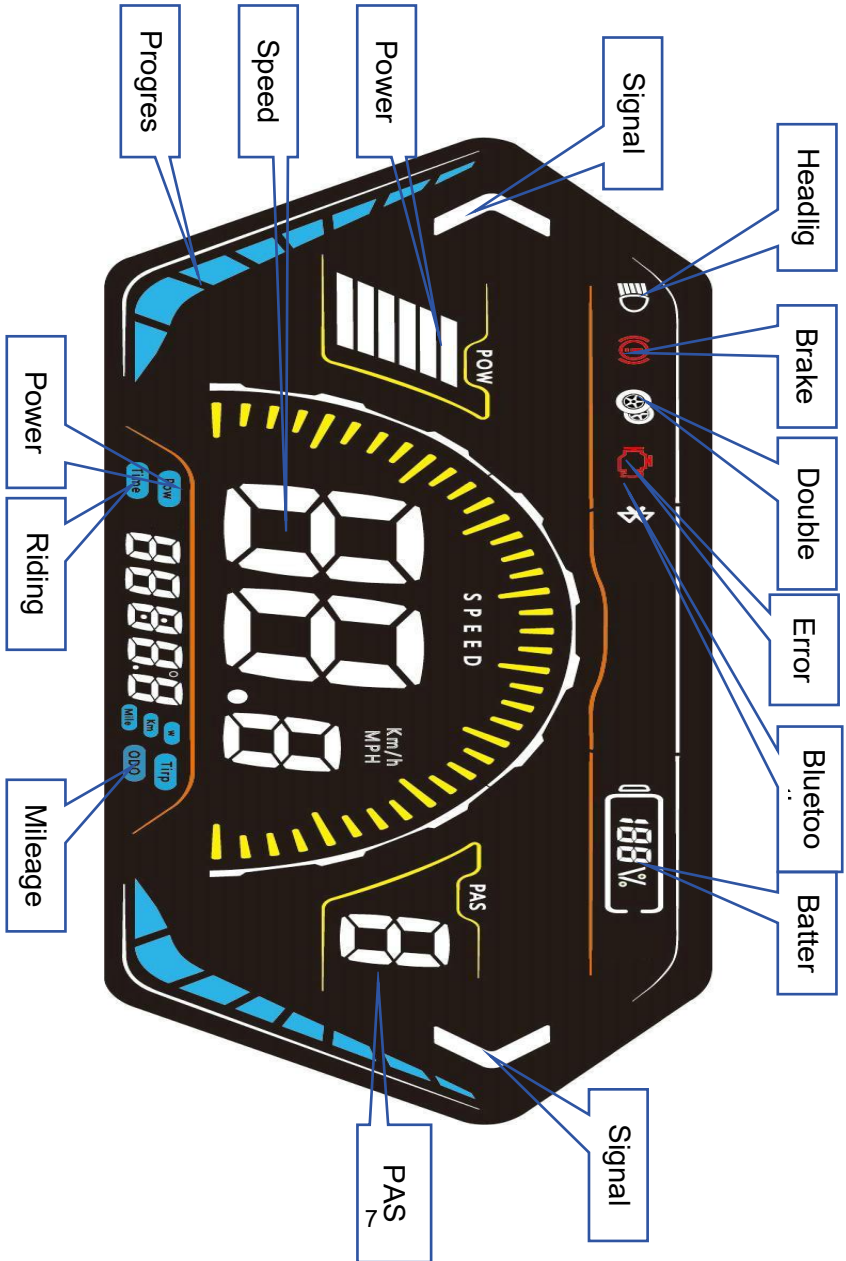

## ◆ Functional Area Distribution



## ◆ General Operation

### 1) Power ON/OFF

Press and hold POWER button to turn on or turn off the display. The display will automatically shut down if you do not operate it for 5 minutes.

### 2) PAS Level

Click on PLUS or MINUS to change the assist level. When power is on, the default assist level is 1.

### 3) Mileage

Press POWER button to switch mileage mode. TRIP→ODO→TIME→POW.

### 4) Headlight

Press PLUS button 3s to turn on/off the headlight.

### 5) Walk mode (6km/h push assist mode)

Press and hold MINUS button longer than 1 second to enter 6km/h push assist mode. And the screen shows P. When release the button, it will exit the mode.

### ◆ Warnings:

1. Use the display with caution. Don't attempt to release or link the connector when battery is power on.
2. Try to avoid hitting the display.
3. Don't modify system parameters to avoid parameter disorder.
4. Make the display repaired when error code appears

### ◆ Display Error Code Definition

Error Code	Definition	Solution
21H	Current abnormal	The internal or external equipment of the controller is damaged and needs to be replaced.
22H	Throttle abnormal	Check the throttle handle wires, ensure the connector is intact and the return is in place. Otherwise, replace the throttle .
23H	Motor phase	Check if the motor's three-phase wires are properly connected. Otherwise, replace the motor
24H	Hall sensor fault.	Motor Hall sensor failure, check if the Hall sensor wires are short-circuited, and if the connector is properly plugged in. Otherwise, replace the motor.
25H	Brake abnormal	Check if the brake handle is short-circuited, if the return is in place, or if it is damaged
30H	Communication Error	1. Confirm if the communication protocol matches the controller. 2. Check if the display cable is broken, if the connector is loose, and if the pins of the waterproof connector are bent. 3. Unplug the pedal assist sensor and see if an error is reported. If not, the pedal assist sensor is damaged.

**Note:** When a fault that cannot be eliminated by yourself or a fault that cannot be determined, the internal damage of the motor, controller, charger, battery pack, etc. please send the vehicle to the place of purchase or the company's special maintenance station for inspection and maintenance. During the warranty period, please do not open important parts without authorization, otherwise the company will not guarantee.

# INSTALLATION INSTRUCTIONS

This e-bike needs to be assembled by the following steps when you received it.

## Toolkits:

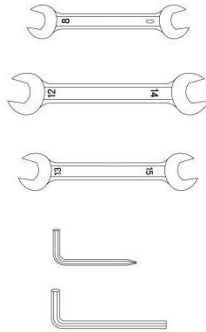

- (1) 8# Open End Wrench
- (2) 12# Open End Wrench
- (3) 13# Open End Wrench
- (4) 5#Hex Wrench
- (5) 6# Hex Wrench

## ◆ Assemble the front wheel

1. Loosen the fixing screws of the front protective rod with a wrench and remove the front fork protective rod.
2. Place the front wheels on the front fork, and make sure the disc brake pads and disc brake calipers are compatible .
3. The small card hooks on both sides of the shaft should be hung together on the small hole at the front, and then tighten the nuts on both sides to fix the front wheels

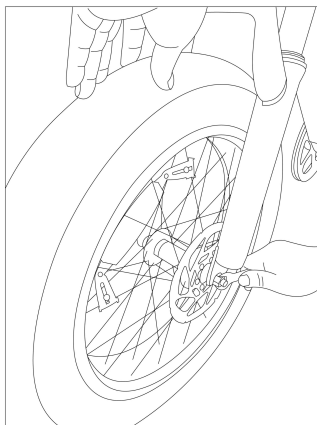
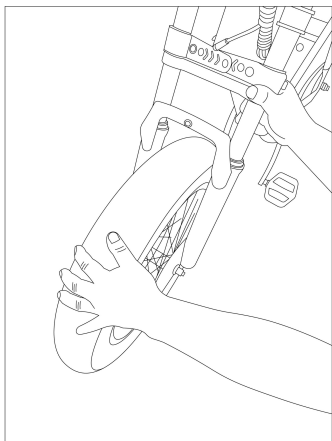

### ◆ Assemble the front mudguard

1. The front mudguard is fixed at the front fork installation hole position, then add screws and washers. After adjusting the Angle, tighten the screws and the installation is complete.

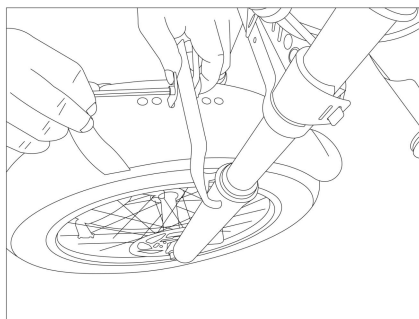
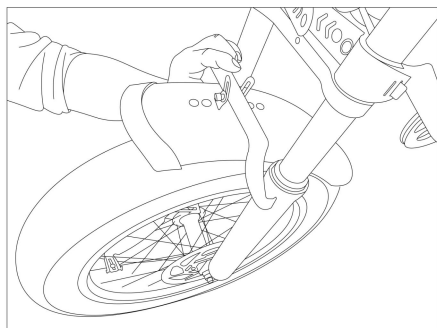

### ◆ Assemble the Handle Bar

1. Loosen the 4 screws on the stem with 5# Hex Wrench, adjust the stem to the suitable position, tighten the screws.

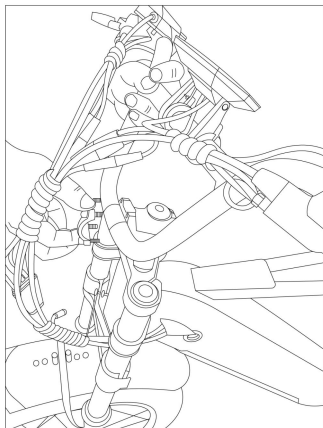

Loosen the screws



Adjust the stem, tighten the screws

## ◆ Install the front light

1. Mix the headlamp bracket apart, prepare the gaskets and screws on both sides, and then tighten the headlamp installation holes. do the same on the other side.

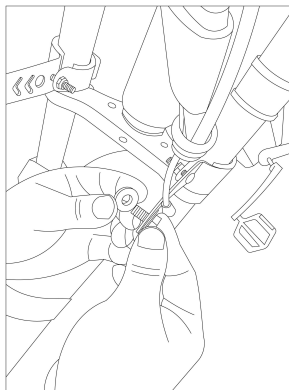
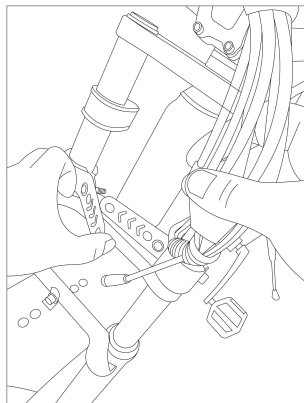

2. Once the headlight wiring is properly connected, the installation is complete.

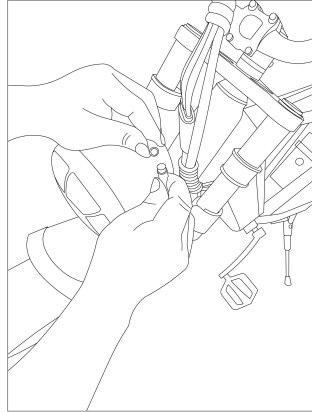
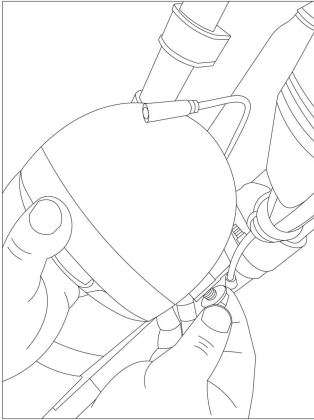

### ◆ Install the saddle

1. Remove the battery, align the six screws of the saddle with the installation holes on the frame, place the saddle properly, then install the screws with washers, and tighten all six screws. The installation is complete.

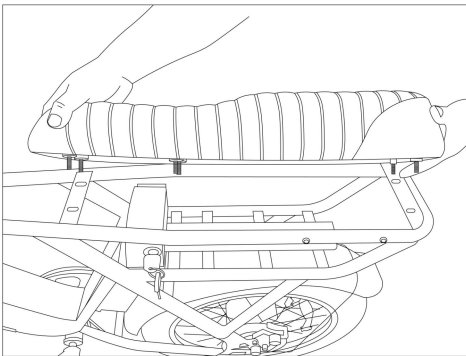

## ◆ Install the pedal

1. Left pedal install with the left crank set ;Right pedal install with the right crank set.
2. Tighten the screws with 15# Open End Wrench

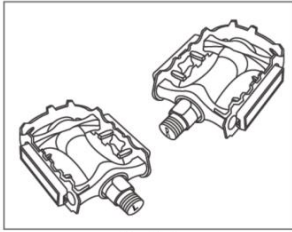

Pedals

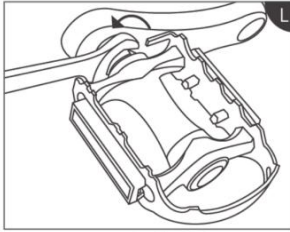

Left

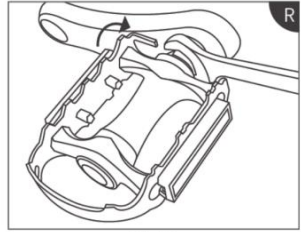

Right

# PRECAUTIONS BEFORE RIDING

Dear users, for your safety and to prevent safety accidents, please do the following checks before riding. If there is any abnormality, please repair it in time or find a professional repair!

## **(1) Inspection of power supply circuit and lighting circuit:**

- Check whether the power supply circuit, lighting circuit and device are damaged; Turn on the power supply, operate the lighting switch, check whether the headlights and taillights are on, and whether the brightness of the headlights and taillights is normal;
- Check that the right brake handle is corresponding to the rear brake, while the left brake handle is corresponding to the front brake, and the brake icon is indicated on the display.

## **(2) Check the brake device:**

- Before every ride: confirm the brake pad thickness is greater than 2.2mm thickness. (Metal plate & wear material)
- Pads and rotors must be kept clean and free of all contaminants including but not limited to oil, lubricants hydraulic fluid, and solvents.
- If the pads or rotors become contaminated you must discard them and replace them with a new set
- Check the pads for wear or contamination.
- Check the hose for cracking, wear or deformation. Replace if necessary.
- Check if the brake system is operating correctly.

## **(3) Check the fastening status of handlebar and front and back wheels:**

- Shake the handlebar up, down, front, back, left and right to check whether it is loose or pongee;
- Shake left and right front and back wheels to check whether there is looseness; whether the rotating wheel is too tight or stuck.

#### **(4)Tire inspection:**

- Check that the wheel inflation pressure is within the range marked on the tire.
- Whether the tire has cracks or abnormal wear;
- Whether the tire is embedded with nails,stones and glass;
- When the tire is used to the tread wear mark,the tire should be replaced.

#### **(5)Inspection of reflector and light:**

- Check whether the reflector is missing.If it is found missing,contact the after-sales service immediately to reassemble the reflector of the same specification and model,and the installation position should be consistent with the original bicycle. Please do not change the position, modify,disassemble,etc.privately.
- Before each use,check that the function of the reflector is normal and the surface of the reflector is kept clean. ·The reflector device cannot be blocked by luggage,children chair,clothes and other objects,otherwise it will cause potential safety hazards.

#### **WARNING:**

- Riding in rainy and snowy days,the braking distance will be prolonged,pay attention to slowdown.
- Heavy rain and other bad weather should try to avoid traveling.
- Should not be used on terrain that could damage the E-bike.

# RECOMMENDATIONS FOR USAGE

## ◆ Battery 1& Battery 2 Removal

### 1. Battery 1 Removal

Insert the key and turn it right, when you hear a click, the battery pops up and you can take it out.

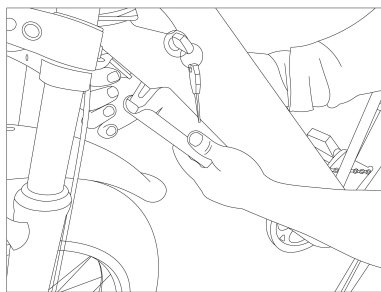
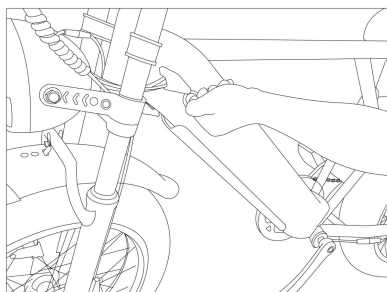

### 2. Battery 2 Removal

hold on to the unlock sign and don't let go, then you can pull out the battery.

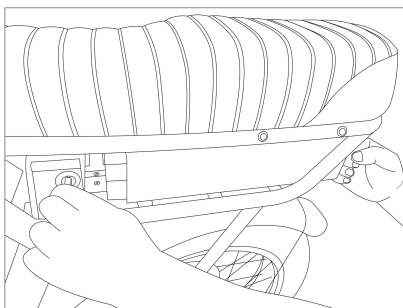

## ◆ Battery 1& Battery 2 Installation

### 1. Battery 1 Installation

Put the battery into the frame. Press the battery into the frame forcefully. Once you heard a click, the battery is has been installed well.

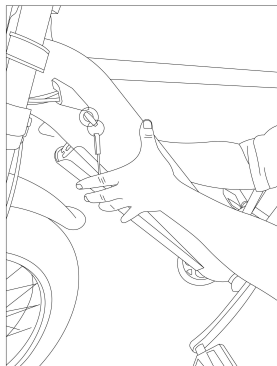

### 2. Battery 2 Installation

Align the battery slide and push the battery in. When you hear a click, it's installed

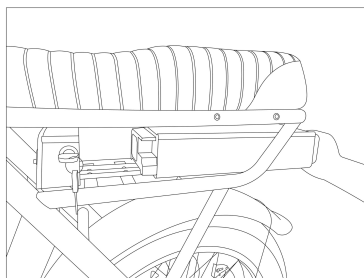

#### **NOTES:**

1. No need to insert the key when installing the battery.
2. The key needs to be inserted when removing the battery. As shown in "Battery Removal".
3. In a safe place: the user can keep the key in the lock all the time.

- 4. In outdoors: it is better to remove the key to prevent the key from being lost.
- 5. When riding: it is better to remove the key to prevent accidental touching.

**WARNING:** Do not attempt to open the casings of the battery, motor, or controller. This can be dangerous and will void any warranties by doing so. Always remove battery during maintenance. Failure to follow these instructions could result in your serious injury or death.

### ◆ Charging

- 1. Take out the battery 1&battery2 and charge the battery separately.

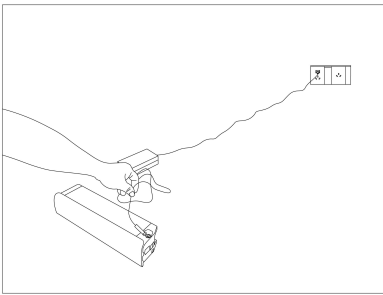

Battery 1 charging

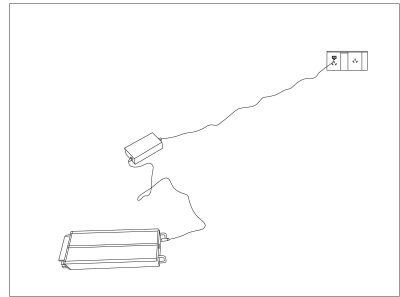

Battery 2 charging

- 2. You can also choose vehicle charging.

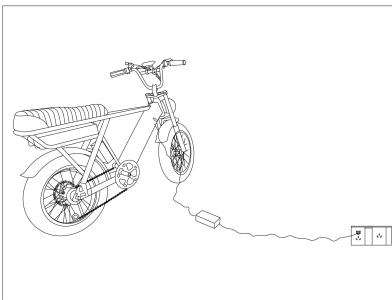

Option 1

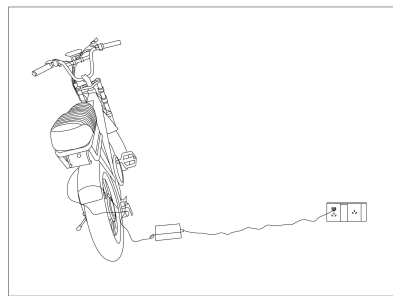

Option 2

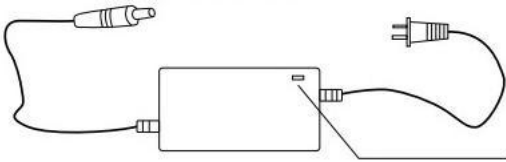

Red light indicates normal charging. Green light indicates charging completed.

#### **NOTES:**

There are 3 lights on the battery:

**Blue:** fully charged

**Green:** with power. For detail power capacity, please check the screen battery indicator.

**Red:** no power, need to charge.

#### **◆ Charging Caution**

1. Ensure the EBIKE is turned off when charging.
2. Ensure that the charging port is clean and dry.
3. Make sure that there is no dust, debris, liquid or dirt inside the port.
4. Plug the charger into a grounded wall outlet.
5. Connect the cable with the power supply (100V~240V; 50/60 Hz).
6. It is forbidden to place any items on the charger.
7. It is strictly prohibited to disassemble and modify the charger;
8. When charging, insert the output of the charger into the charging port of the battery pack first, and then insert the AC power plug of the charger into the Mains socket; It is forbidden to plug and remove the power plug with wet hands.
9. Do not use the charger when thunder and lightning;
10. Do not play with the charger and battery pack when charging;
11. Do not use the charger in unstable, excessive lampblack and dust and excessively humid environments;
12. Keep good ventilation and heat dissipation conditions when the charger works, and avoid using the charger in direct sunlight;

13. When the output of the charger is not connected to the battery pack,do not connect the charger to the mains for a long time;
14. During the charging process,the indicator light of the charger is red.When the indicator light turns green, battery is fully charged;
15. The normal charging time is 6-7 hours (no more than 12 hours),and the fast charging station is not allowed to charge.

**Note:** Only use the provided charging cable to charge your E-bike's battery pack. Using any other unauthorized charger may cause damage to your battery pack.

### ◆ Precaution for washing

1. When washing the bicycle,do not directly splash water on the brake drum,motor and front and rear axle to prevent water from affecting the service performance and life.
2. Turn off the E-bike before washing.
3. Ensure the E-bike battery is locked in place.
4. Make sure the cap over the charger port is secured.
5. Do not wash your E-bike upside down. Flipping the bike upside down to wash it can cause water to pool in the motor and battery, causing damage.
6. Do not use a power washer or high -pressure water pipes when washing your E-bike.
7. Avoid using any strong chemical cleaners.
8. Always dry your E-bike fully before storing it. Residual water left sitting on electrical components could cause damage.

# MAINTENANCE AND REPAIR

1.The vehicle should be kept clean and clean,and the vehicle should be wiped with dry cloth in time after being drenched to avoid rusting of parts and short circuit of electrical components.

2.Always check the air storage capacity of the tire to keep it in normal use.Max:210kPa ;Suggest: 170kPa.

Location	Method	Time
Wheels	Check the wheel swing,spoke tension,spokes,mother spoke for damage;Adjust the wheel	Once every three months
Brake Pad	Check the pads for wear or contamination,pads should be replaced if they become contaminated or have less than 2.2mm thickness. (Metal plate & wear material)	Once every three months
Brake Rotor	Check the rotor for wear or contamination, 2.3mm thickness rotor should be replaced if worn to 1.9mm thickness.1.8mm thickness rotor should be replaced if worn to 1.5mm thickness.	Once every three months
Chain	Check whether the pin shaft is loose or bulging,and whether the extension of the chain is too large.	Once every six months
Front and rear nut,handlebar core screw,saddle clamping screw	Check for looseness	Once every six months

3.The main transmission parts such as front hub, center hub,front fork,Freewheel and motor hub should be checked and adjusted frequently to keep the transmission parts flexible without impact sound and noise;Check the screws and nuts of the bicycle,if it is found that it is

loose,it should be tightened in time to prevent the parts from being worn out or causing greater damage and fracture due to looseness.

4.Electric bicycle moving parts should be often injected with a small amount of lubricating oil to reduce wear and keep riding light, as shown in the following table:

<b>Lubrication part</b>	<b>Lubricant</b>	<b>Lubrication cycle</b>
Front hub	32#calcium-based lubricating oil	Six months to one year
Front fork headset	32#calcium-based lubricating oil	Half a year
Chain	32#calcium-based lubricating oil	Each month
Freewheel	32#calcium-based lubricating oil	Each month

5. Battery failure conditions:

<b>Conditions</b>	<b>Failure &amp; Solution</b>
Driving normally, but the battery indicator light is not on	Battery circuit failure
The battery indicator light goes on normally, but after you installed the battery, the e-bike still don't work.	Display,battery or controller failure,need to test display, battery and controller
The battery indicator light shows normally,and the e-bike can be ridden normally, but it don't charge.	Charger or battery protection board failure
Battery indicator light shows normally, but there is an error code 21 appeared when the battery was installed.	Battery or controller has under-voltage, need to test battery or controller

**Note:**

1. When doing bicycle maintenance, the battery must be removed to avoid abnormality that may cause fire or damage to the battery.
2. Original parts should be used in repairing or maintaining the bicycle, otherwise your bicycle may not work properly, or related parts may be damaged.
3. If repair by yourself, please purchase parts from authorized suppliers and follow the operating instructions when buying.
4. If a problem cannot be solved by yourself, please send the vehicle to the place of purchase or the company's special maintenance station for inspection and maintenance.

# WARRANTY CARD

USER'S INFORMATION	
Name	
Address	
Model No.	
S.N	
Purchase Date	

WARRANTY RECORD			
Service Date	Fault and solution	Finish Date	Sign

## Guarantee clause:

To purchase this product, please fill in this card carefully and read the warranty terms carefully to ensure that the product is in valid warranty.

# DECLARATON OF CONFORMITY

We

Manufacturer's Name: Shenzhen Yangor Intelligence Technology Co., Ltd.

Manufacturer's Address: Rm 306, 3rd Floor, Building 2, No. 52, Zhonghao 1st Road, Xiangjiaotang Community, Bantian Street, Longgang District, Shenzhen, China

herewith declare that this product

Product: Electric assisted bicycle  
Model(s)/Type(s): Y20 Pro Max

Fulfills all the relevant provisions of following EC Directive:

Machinery Directive (2006/42/EEC)

With the following harmonized standard:

EN15194:2017+A1:2023

Shenzhen Yangor Intelligence Technology Co., Ltd.

Rm 306, 3rd Floor, Building 2, No. 52, Zhonghao 1st Road,  
Xiangjiaotang Community, Bantian Street, Longgang District,  
Shenzhen, China