

Ningbo Kaabo Technology Co., Ltd.

Add: 3rd Floor, Building B3, Shanshan New Energy Base, NO. 238 Yunlin Middle Road,
Haishu District, Ningbo Zhejiang, China

Tel: 0086-0574-88321118

Email: sales@kaabo.com

Web: www.kaabo.com

WOLF WARRIOR X

User Manual

BEFORE YOU START

This product is an electric scooter, used for short distance walking, please use this product under safe road

It is important to read through, understand, and adhere to all the instructions and safety warnings in this manual before charging and operating this scooter.

Upon receiving and opening your box, please inspect the contents for signs of damage or loose screws from transport. If something doesn't feel right, please take a few pictures and contact your place of purchase immediately.

Your scooter comes with a 180-day limited warranty against manufacturing defects. In case of any issues beyond this time frame, we will still help you but we may need to charge a fee for spare parts or repairs.

If you have purchased your scooter from a dealer other than kaabo.com, please contact them first in case of any issues. If you still need help or you have purchased directly from kaabo.com, please feel free to contact us with any questions or concerns.

Make sure you understand and adhere to local rules and regulations for riding electric scooters. Riding an electric scooter comes with inherent risks and hazards. To minimize risk of falling or being injured, make sure you understand how to safely operate and control this scooter.

Always use good judgement, common sense, and protective gear.

TABLE OF CONTENTS

BEFORE YOU START	1
TABLE OF CONTENTS	2
GENERAL SAFETY WARNINGS	3
WOLF WARRIOR OVERVIEW	4
What's in the Box.....	4
Caution.....	5
Product Structure.....	7
Name of each part.....	8
Product components.....	9
How to use the product.....	10
How to use the instrument panel.....	13
How to use a charger correctly.....	23
Product Specification.....	25
Adjustable color pedal lamp.....	26
Electric wiring diagram	27

GENERAL SAFETY WARNINGS

Always wear a helmet and protective safety equipment.

Wear closed shoes without heels and ensure your laces are tied.

Do not ride with more than one rider or exceed the weight limit of 100kg/220lbs in any other way. Only use your scooter in line with its intended purpose.

Check your scooter for any loose parts or screws, flat tires, signs of damage or excessive wear before every ride. Stop operation immediately and contact your place of purchase if something does not feel right.

Start riding slowly to familiarize yourself with the operation of your scooter. Start in first gear and slowly try out the brakes. Always slow down when riding over bumps or on rough road conditions. Keep the scooter away from children. It is not a toy. Riders must be age 16+ only.

Do not use your electric scooter in heavy rain, or on surfaces covered by more than 1/2 inch of water. Do not submerge the scooter in liquid or let any liquid near the battery or electrical components.

Do not lend your scooter to anybody unfamiliar with its operation. Ensure any new riders are familiar with these instructions and are wearing proper safety gear.

Once riding in public space, you are subject to the risks faced by all traffic participants just like when you are riding a bike.

Other traffic participants may not obey traffic regulations or may ride carelessly. The faster you ride your scooter, the longer it will take you to stop.

The scooter may slip on slippery surfaces leading to subsequent injuries to the rider. Pay special attention crossing train tracks and/or when it is wet.

Always use caution, adapt your speed to road and traffic conditions and keep distance from other traffic participants.

Watch out for pedestrians. Do not use your scooter in any way that could harm pedestrians. Slow down when you are passing them to avoid accidents.

You must follow all local traffic rules and regulations.

MANTIS OVERVIE

What's in the Box:



Electric scooter



User Manual



Standard charger



Tool

Matters needing attention:

1. The braking distance will be extended in wet weather
2. Different materials and components may react differently to wear or fatigue. If the intended life of a component has been exceeded, it may suddenly break, thus potentially causing harm to the user. Cracks, scratches and discoloration in areas susceptible to high stress indicate that the component has outlived its service life and should be replaced."
3. Please check the light and road conditions when using at night.

Rated Capacity: 60V 21AH

Input: 67.2V 1.75A



60V 27AH

60V 28AH

60V 28.8AH

WARNING! Please turn off the scooter when charging

WARNING! Don't charge the flooded scooter and check with a professional

WARNING! Don't charge the scooter when no one is present or while sleeping

WARNING! Don't charge the scooter when you find an electric shock and check with a Professional

WARNING! Don't charge or leave the battery storage under a high-temperature above 40 degree

WARNING! Don't touch the charging port with the wet hands

WARNING! Do not charge near fire

Devices are not intended for use at elevations greater than 2000 m above sea level.

Prolonged Exposure to UV Rays, Rain and the Elements May Damage the Enclosure Materials, Store Indoors When Not in Use
WARNING – Risk of Fire – No User Serviceable Parts

AVERTISSEMENT- Risque d'incendie et de choc électrique - Aucune des pièces ne peut être réparée par l'utilisateur



Caution

1) Safety guidelines and restrictions

* Even if the it is within the warranty period, you may be liable for any accident caused by any of the following causes.



1. Be careful of water!

This product and components are not waterproof. Don't let the water get into the product and components.

* Never use it, if the road is wet due to the rain, snow, hailstone.

* If you wash or spread water to electric devices, it can result in malfunction or fire.



2. Beware of folding and spinning parts!

If parts of the body, as a finger or hair, get caught in the spinning or folding parts of the product, this may lead to severe injuries. Please be careful.



3. No acrobatics

Stunts and jumps such as jumping and dropping are prohibited as they can cause a great impact on the product and can cause malfunction and accidents.



4. No companion boarding

This product is intended for one adult only, so children, infants, or two people are prohibited from boarding.



5. Don't tune by yourself

Do not open or tune the electric parts (battery, controller or motor system).



6. Comply with the related laws

Unlicensed, driving after drinking, loading cargo on the scooter is prohibited. (More than bike or bicycle license is required)

Please comply with the Road Traffic Act and related laws and regulations according to the place of use.



7. Beginners and seniors are encouraged to use at low speed

Beginners who are not accustomed to use the product, seniors and others should avoid high speed mode driving and recommend low speed driving. In addition, please use after practice how to ride safely in a wide place.



8. Do not sudden brake with front brake

If there is a risk of overturning, sudden deceleration should be done safely. Do not apply any unusual behaviors or artificial forces, such as stopping with your feet.



9. Do not accelerate downhill

Slow down at downhill. When reducing the speed, to prevent brake overheat, use the brakes properly to reduce the heat on the disk with proper brake use.



10. Do not drive on steep slopes

Acceptable gradeability is different for each product. Excessive hill roads exceeding the specification may cause damage to the product (parts) due to temperature cut, overcurrent or low voltage cut, which may cause the product to malfunction.



11. Safety warning when lifting the product

If the product is lifted by holding only the handle, there is a possibility that the product may be damaged due to deformation of the folding part due to load or movement of the product. When lifting the product, be sure to hold the product's body (footrest) with one hand and hold the handle with the other hand so that you do not get hurt in your back or knees.



12. Be sure to wear safety equipment

For the safety of passengers, be sure to wear a full face helmet and the other protective gear (knee, elbow, hand, upper body) and do not wear shoes such as slippers, high heels that interfere with driving.

2) Precaution before driving

1. Night driving should be avoided in any case, be sure to wear helmets and other guards (knees, elbows, hands, upper body, etc.) and drive safely.
2. Select the mode that suits you and drive. In order to cope with the sudden situation, exercise to slow down to hold the brake at all times.
3. When turning left / right, slow down to avoid danger of overturning or slipping. And then slowly turn safely.
4. To go to backward, it is safe if you get off from the product after stopping before moving.
5. It is prohibited to use in a slippery place, a crowded place, a steep slope, roads with a risk of accident, uneven road.
6. When crossing a pedestrian crossing, get off from the product for pedestrian safety.
7. Do not drive in a threat any other means of transport, such as animals, pedestrians, bicycles, motorcycles, cars, etc.
8. If you pass the speed bumps and obstacles, be sure to slow down.
9. When decelerating or braking, do not stop with using foot, but stop with using brake appropriately.
10. Be careful that there is a risk of burns due to heat from motor and brake (especially disk rotor) after driving.
11. It is prohibited to drive with all the way by holding the handle with one hand.
12. Do not ride or drive when the kick stand is down.

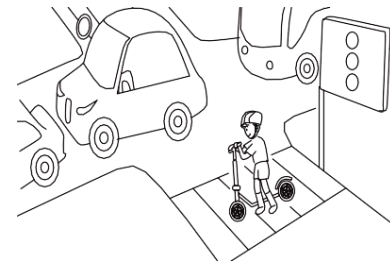

Product structure

Electric wiring diagram

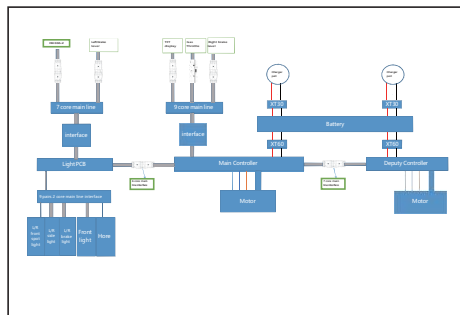

Wolf Warrior X GT

Product size

Unfolded



Folded



Name of each part

WOLF WARRIOR X

Handle

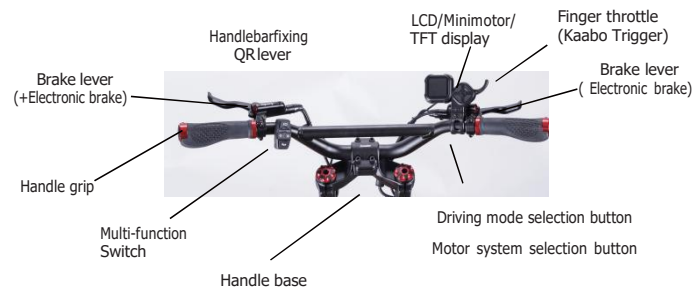

Body frame



Product components



Checking the components inside of the box

Top: Standard battery charger (1.75A), Standard tool, User manual, Labeling, Body (Lithium battery included)

Take out the scooter from box



Do not hold the handlebar only when lifting the product from the box.

Please be careful that the fixing slide of the folding part may be damaged, and a safety accident such as a part of the body may be caught.

Therefore, when lifting the product, it is necessary to raise the handlebar first, and then slowly lift the body (footrest) of the product with both hands and do not damage the folding part.



Check whether the instrument screws are tightened

Make a note of the serial number



The serial number can be used to check information such as date of purchase, warranty period, etc., and product information can be checked even if the product is lost or stolen. (May vary depending on branch office situation.)



How to use the product

WOLF WARRIOR X

1) Product folding

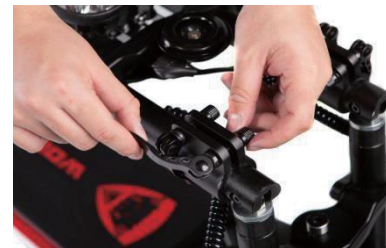

1. Raise the handle post (Steering tube)

Release the locking clamp, raise the locking slide upwards, raise the handle post, then lower the locking slide downward.



2. Lock the folding parts

Tighten the finishing screw properly to lock the clamp, so that the locking slide is firmly fixed in any direction, and check for looseness during use.

How to use a product

2) How to start



Step2. Stance for driving

After tilting the kickstand, find a stable position on the footrest and then hold the handle grip comfortably. Be careful not to raise your foot on the rear fender.



Caution

Before driving, be sure to check the folding part, the handle part, the part where the main fixing part of the product is fastened well. And check the position of the fixing slide, the QR lever locking status and the folding part fixing status.

Throttle malfunction caution

Regardless of whether the throttle is operated or not, the motor sensor may continue to operate, causing malfunctions such as sudden acceleration. In this case, holding the brake lever to cancel the operation. This phenomenon may be caused by corrosion of the throttling, immersion of the throttle, disconnection of the magnet, broken off levers, and breakage of the spring. Do not bounce the throttle lever strongly.

Step1. Turning on the main switch

When turning on the product, you can start driving by turning on the main power switch first (when using the built-in battery) and turning on the power of the LCD panel. When driving is finished, turn off the LCD panel and turn off the main power.

* The power of the instrument panel will turn off automatically after a few minutes of inactivity. At this time, the LED lamp is also turned off, so turn it off with the LED lamp button when you turn it on again, and turn off the main power switch after use.



Step3. Acceleration and deceleration

Acceleration can be performed by using the throttle of the instrument panel while driving, and the deceleration or stop can be performed by holding the brakes on the handle.

3) How to stop

Be sure to use the rear brake first for decelerating when stopping while driving. For safe stop, it is necessary to practice slow down after deceleration with rear brake.

Always use the front and rear brake levers together to stop smoothly and safely after decelerating with the rear brake.



Set the use and strength of the electronic brake among the detailed functions of the instrument panel before driving. When the brake lever works, the electronic brake works together to increase the braking force.

Tip

Check for safe braking

• For safe braking, check whether the brake lever and disc caliper connection (wire damage, external breakage, etc.) are damaged before and after driving, and check brake wear and looseness of brake inner core (Inner wire). In the case of hydraulic brakes, it is also necessary to check the oil leakage or deficiency and always check that the braking force is sufficient.

• Due to various factors such as road surface condition and speed, it may not be possible to stop when brake is operated as expected. The electronic brake and ABS functions are auxiliary functions to further increase the braking force and used. The user should understand the function and expect the operation timing when use this function.

4) Product folding

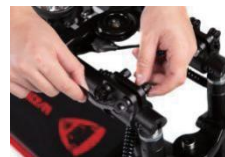

How to use the instrument panel



1. Speedometer: Shows the speed at which you are travelling.
2. Battery Indicator: Shows the level of the battery. Charge your scooter frequently, do not let it run out of battery. As a rough guideline, charge at or below 2 bars.
3. Gear: Shows the selected gear.
4. Gear selector: Press to set gear (1=slow, 2=medium, 3=fast).
5. Power Button: To turn the scooter on or off, press button for 2 seconds.
6. Accelerator: Pull to accelerate. The stronger you pull, the faster it accelerates. The scooter is delivered in "Non-Zero Start" setting (Kick-And-Go is ON). The accelerator only works if the scooter is already in motion.
7. Mode Button: Press to select various display options:

MODE	COMMENT
TIME	Time since powering on the scooter.
TRIP	Distance travelled since powering on the scooter.
ODO	Total distance travelled.
VOL	Current battery voltage.
CHA	Number of times battery has been charged (only full discharges are counted)

WOLF WARRIOR X

PSETTINGS	
P0	Tire diameter 10. Do not change.
P1	System voltage. Default 60V. Do not change.
P2	Motor magnetic pole setting. Default 15. Do not change.(Mantis 10) Motor magnetic pole setting. Default 10. Do not change.(Mantis 8)
P3	Speed signal selection. Default is 0. Do not change.
P4	Distance / speed unit. 0=km, 1=miles
P5	Start setting. 1=non-zero start (Kick-and-Go), accelerator won't work if scooter is not in motion; 0=immediate start (CAUTION while using this)
P6	Cruise control. 0=cruise control OFF, 1=cruise control ON. Advanced riders only.
P7	Initial acceleration. 0=strong power, 5=least power.
P9	Motor torque. 1=50% of max. torque, 2=75% of max. torque, 3=max. torque
PA	Electric (regenerative) braking strength (E-ABS). 0=None, 1=Weak, 2=Medium, 3=strong.
PB	Display brightness (0=off, 5=highest illumination)
PC	Scooter auto-turn off time in minutes (1-30 minutes).
PD	ABS (anti-lock braking system) setting. 0=ABS off, 1=ABS on (as in a car, the brake engages and disengages rapidly to prevent the wheel from blocking) WARNING: Due to increased vibration and force and on scooter components when using ABS, frequently check that all bolts are properly fastened.

Cruise Control. Cruise control allows you to maintain your driving speed automatically without continuing to hold down the accelerator. In order to enter Cruise Control, activate it first in the P-settings [P6].

While driving, keep the accelerator steady for 3-5 seconds until Cruise Control kicks in and scooter travels at a constant speed without driver holding down the accelerator. When you activate the brakes, Cruise Control will be cancelled. CAUTION: Ride in a position where you can immediately access the brake to cancel Cruise Control if necessary.

How to use the instrument panel



Caution

Option 1:



1. Speedometer: Shows the speed at which you are travelling.
2. Battery Indicator: Shows the level of your battery. Charge your scooter frequently, and do not let it run out of battery. As a rough guideline, charge at or below 2 bars.
3. Power Button: To turn the scooter on or off press the button for 2 seconds.
4. Accelerator: Pull to accelerate. The stronger you pull, the faster it accelerates. The scooter is delivered in "Non-Zero Start" setting (Kick-And-Go is ON), i.e. the accelerator only works if the scooter is already in motion.
5. Mode Button: Press to select various display options:

TIME	COMMENT
TIME	Time since powering on the scooter.
TRIP	Distance travelled since powering on the scooter.
ODO	Total distance travelled.
VOL	Current battery voltage.
CH2:00	Charging mode. Time (2 hours) scooter stays ON (overrides auto-switch off) so you can use the display's USB port to also charge things e.g. your phone.

WOLF WARRIOR X

P-SETTINGS	
P0	Tire diameter 10. Do not change.
P1	System voltage. Default 530 .Do not change.
P2	Motor magnetic pole setting. Default is 30. Do not change.
P3	Speed signal selection. Default is 0. Do not change.
P4	Distance / speed unit. 0=km, 1=miles
P5	Start setting. 1=non-zero start (Kick-and-Go), accelerator won't work if scooter is not in motion; 0=immediate start (CAUTION while using this)
P6	Cruise control. 0=cruise control OFF, 1=cruise control ON.
P7	Initial acceleration. 0=soft, 1=strong.
P8	Electric (regenerative) braking (E-ABS). 0=E-ABS off, 1=E-ABS on
PA	Clear total distance travelled (ODO).
PB	Scooter auto-turn off time in minutes.
PC	Display brightness (1=low, 2=medium, 3=high)

Cruise Control. Cruise control allows you to maintain your driving speed automatically without continuing to hold down the accelerator. In order to enter Cruise Control, activate it first in the P-settings [P6].

While driving, keep the accelerator steady for a few seconds until Cruise Control kicks in and scooter travels at a constant speed without driver holding down the accelerator. When you activate the brakes Cruise Control will be cancelled. CAUTION: Ride in a position where you can immediately access the brake to cancel Cruise Control if necessary.

Option 2:



See the details in the attached manual

How to use the instrument panel



Caution

WOLF WARRIOR X



See the attachment for more details



How to use the instrument panel



Caution

WOLF WARRIOR X



See the attachment for more details



How to use the instrument panel

WOLF WARRIOR X

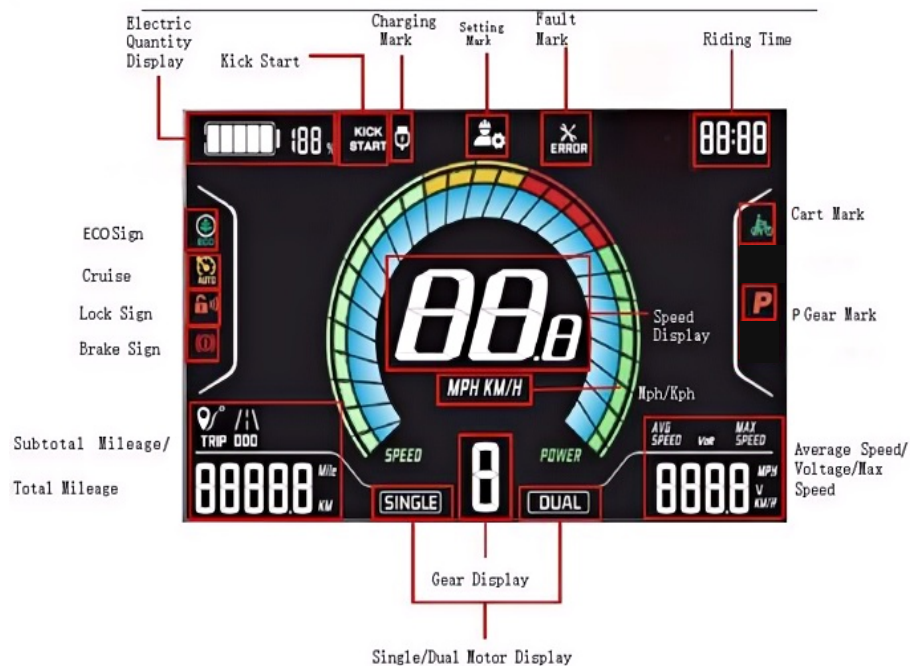

Display interfaces

MODE	description
UNT	System unit(default locking is not adjustable)
BLG	Instrument backlight settings 1gear gear, 3gear can be selected, 3gear for the brightest backlight mode
SLP	The automatic OFF time of scooter instrument, in minutes, is 0, 5, 10, 10, 20, 30 minutes. After this setting is complete, the scooter will automatically Off within the set time without any operation
DSP	Instrument software version number, lock
psd	Password set (default=1500)
SET	Advanced Settings (password=1500)
RST	Reset system (Y=yes n=no)
Advanced Settings	
P1	Motor wheel diameter set, Set according to the actual wheel diameter, The general value is (10), please do not change
P2	Speed limit as % of top speed, i.e. 100=no speed limit.
P3	Motor magnetic pole setting, Default is 30, Do not change.
P4	E-ABS, 1=EABS ON, 0=E-ABS OFF
P5	EBS, There are five gear 1-5 1=weakest, 5= strongest
P6	Start setting, 1=non-zero start (Kick-and-Go), if the scooter is not moving, the accelerator will not work; 0=Start immediately (note when using)
P7	Fixed speed cruise setting, 0 is no fixed speed cruise, 1 is automatic fixed speed cruise
P8	System voltage, 60V, default 60V please do not change
P9	Undervoltage value, 48V default lock 48V please do not change
P10	Starting mode, 0 is hard start, a total of 5 levels can be selected, 1 is the soft start, 4 is the softest start (Only available if have this function)
P11	Driving mode, There are three modes: 0, 1 and 2. The drive mode can be manually adjusted in 0 mode, 1 is the default single-drive, 2 is the default dual-drive, The default mode is 2, Do not manually modify the parameters.

How to use a charger correctly





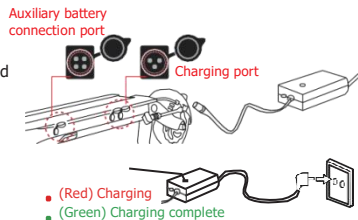

1) Basic charging method

1. Open the charging port cap and connect it to the connector of the charger and connect it to the household outlet.
2. Charging status indicator
3. Be sure to close the charging port cap when driving or storing except when charging.
4. When connecting the connector to the charging port, metallic sparks due to voltage difference may be splashed, but this is normal



2) Basic charging method

* Failure of the charger and abnormal conditions can cause electric shock and fire. Learn the correct usage and prevent safety accidents in advance.

 <p>1. Manufacturers and sellers are not responsible for any problems arising from any disassembly, modification, or mixing with other chargers.</p>	 <p>2. The charger is forbidden to be used in places subject to high humidity, heat, flammable materials, confined spaces, or where there is no ventilation such as in a car.</p>
 <p>3. The charger is not waterproof. It is thoroughly controlled to prevent moisture from entering the charger.</p>	 <p>4. Children and pets should not be allowed to approach the charger when they come into contact with them, as they may cause an electric shock.</p>
 <p>5. If the charger lamp does not light, charger fall, strong external shock, long time charge, or cable c over damage, discontinue use immediately and contact the service center.</p>	<p>6. Unplug the charger when you are away from the home for long periods of time.</p> 

7. Use only genuine charger.
8. Do not insert conductors into the charging port.
9. Do not touch the plug for about 10 seconds after unplugging the charger. There is a risk of electric shock from instantaneous discharge.
10. Do not remove the terminal during charging. Charge the internal circuit of the charger and cause malfunction.
11. Do not operate the product during charging.
12. Charging terminals should be firmly contacted during charging and should not be used if terminals are corroded or damaged.
13. When disconnecting the charger from the product, it is safe to hold the terminal without holding the wire.

- * Short-circuit Caution: Be careful not to short-circuit the battery because short-circuiting of the battery is very dangerous.
- * Over current Note: The battery of this product is designed to automatically shut off the power supply to protect the battery when the over current is over 100A.
- * Low Voltage Caution: The battery of this product is designed to be automatically shut off when the voltage drops below 48V. Do not use the product in the low voltage state.



How to use a charger correctly

WOLF WARRIOR X

1. **Care** Lithium batteries should be protected from direct exposure to children and pets.
2. **Performance**
 - ① Lithium battery is affected by external temperature. In winter, when the temperature is low, the performance of the battery is temporarily deteriorated and the mileage and power output is reduced.
 - ② Lithium battery has a characteristic that discharge performance is reduced by more than 15% when charging / discharging 300 times or more. If usage time is shortened due to long usage, it should be replaced with a genuine one through the nearest point.



3. **Charging**
 - Ⓢ Lithium battery should be used only with genuine battery and charger supplied from the manufacturer. Any problems caused by use of battery made by the manufacturer, mixed use, or using the charger are not covered by the manufacturer.
 - Ⓢ Charging the lithium battery with a non-genuine charger may cause malfunction or fire.
 - ③ The lithium battery should be charged in a well-ventilated, dry place and around the charger in a place where there is no inflammable material.
 - ④ Lithium battery should be charged at 0~40°C and discharged within -20~40°C. Charging or discharging at a temperature outside this range may cause malfunction, fire or explosion. In case of moving from cold outside to warm in door, please charge it after 1 ~ 2 hours. This is to prevent condensation from occurring inside the product due to temperature difference.
4. **Storage**
 - Ⓢ Lithium batteries should be kept away from snow, rain and direct sunlight. Do not store or charge them in a trunk or hotroom. Select a dry place and store at room temperature (10~20°C).
 - Ⓢ When storing for more than 3 months, charge the battery level to 70~80% (do not store full charge).
5. **Trouble symptom, safety** Lithium battery should be discontinued immediately if it is damaged or leakage of battery, sour odor, appearance deformation, etc., and contact the place of purchase to get technical support and service.
 - Ⓢ If overheat, smoke or ignition is detected in a product with lithium battery, immediately stop charging and use, move the product outdoors as soon as possible, and then use a fire extinguisher to evolve. Do not spray water or immerse the product in water to evolve, which is more dangerous.
 - ③ Lithium battery pack has very high energy density, so if you charge the battery for a long time in case of short-circuit, leakage, bad battery, etc., there is a possibility of ignition. Therefore, you should avoid charging for a long time without a person, and charging must be done while the person is aware that the risk of unexpected fire can be avoided.
6. **Misuse** If the lithium battery is short-circuited or the polarity is changed, or if the battery is impacted, malfunction or fire may result. If you think that the battery has been impacted, you should stop charging and using it and visit the nearest point for inspection.
7. **Water inflow** It should be controlled to prevent water from flowing into the lithium battery. There is a risk of fire or electric shock if the charger is connected while moisture is present.
8. **Caution** Disconnect the battery from the main unit and prohibit recharging, reinstalling, or using other applications.
9. **Disposal** When disposing of the lithium battery, the battery should be separated from the product at the point of purchase or near the point so that the charge and discharge terminals are not short-circuited. Dispose of it as industrial waste when disposing of it.



- Danger** Battery disassembly prohibited
- Battery disassembly, modification and repair are not covered under warranty.

Product Specification

Wolf Warrior X				
Version name:	Wolf Warrior X PLUS	Wolf Warrior X PRO+	Wolf Warrior X GT	Wolf Warrior X MAX
Color	■		■	
Battery Model	DMEGC26E	LG/Samsung	LG/Samsung	KB-WF6027DD1
Configuration	60V21Ah	60V28Ah	60V28.8Ah	60V27Ah
Motor power	1100W*2			
Max speed	Around 25 km/h			
Max Range	Around 70 km	Around 100 km	Around 110 km	Around 90 km
	(75kgs load ,25 km/h flat road ride at constant speed,full of electricity,sufficient air pressure)			
Climbing Angles	<35°			
Max Load	100kgs			
Charger	67.2V 1.75A 1+ 3-		2*67.2V 1.75A 1+ 2-	2*67.2V 1.75A 1+ 2-
Charging time (Use 1.75A*1)	Around 12 hrs	Around 16 hrs	Around 16.4 hrs	Around 15.4 hrs
Charging time (Use 1.75A*2)	Around 6 hrs	Around 8 hrs	Around 8.2 hrs	Around 7.7 hrs
Charging time (Use 5A*2)	Around 2.1 hrs	Around 2.8 hrs	Around 2.9 hrs	Around 2.7 hrs
Shock Absorber	Front patent hydraulic shock absorber+RearC spring shock absorber			
Brake	Front and rear hydraulic brake(140)+ABS		Front and rear hydraulic brake(140)+EABS	
Light	LED Pedal lamp(RGB Set different colors on your phone) +LED front spotlight+LED turnlight+LED front light			
Horn	Motorcycle-grade horn			
Controller	Sine Wave controller	Minimotors controller	SineWave controller	SineWave controller
Open size	1251*650*1228mm			
Folding size	1251*650*578mm			
N.W	37.3kgs	37.4kgs	38.4kgs	37.9kgs
Packing box size	131.5*31.5*64cm			
Tyres	10*3.0(Street tyres/Off-road tyres/all-terrain tyres)			
Display	LCD Display	Minimotors display	TFTdisplay	Center display
Product materials	Handle,frame,bar materia 6061-t6 aluminum alloy and 6082-t6 aluminum forging; CoverPP;Shaft scm440			
Certification	EN17128-2020;IPX5;			

*The specification can be changed by manufacturer without notice to improve the quality and safety for users.

*The distance can be affected by loaded weight, wind direct (wind speed), road condition, slope and tire condition

WOLF WARRIOR X

MEMO

Adjustable color pedal lamp

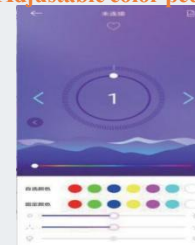

1. Nearly 100 lighting modes available
2. Free choice of colors
3. Color brightness and change speed can be adjusted at will



Charger information:

Object	Manufacturer	Model	Technical data
Battery Charger	JIN XIN YU POWER(SHENZHEN) SUPPLY CO LTD	XVE126-6720175	Input: 100-240V a.c, 50/60Hz, 2.5A; Output: 67.2V d.c., 1.75A., 117.6W
Battery Charger	Alrightpower New Energy (huizhou) Co., Ltd	AP-PF360CH06720050	Input: 100-240V a.c., 50/60Hz, 5A; Output: 67.2V d.c., 5.0A., 336.0W

WOLF WARRIOR X PLUS/MAX wiring diagram

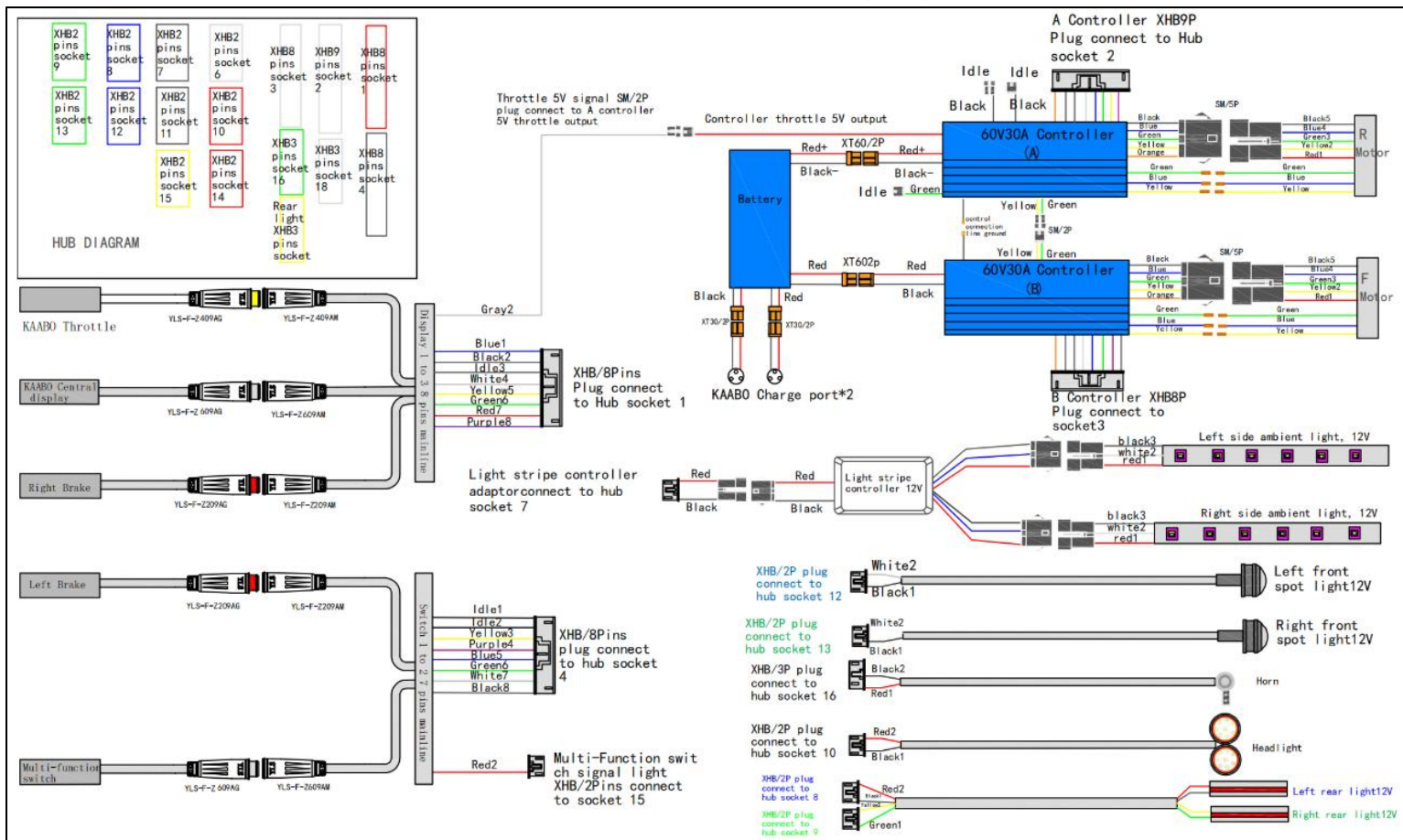

WOLF WARRIOR X PRO+ wiring diagram

